

Handwritten signature

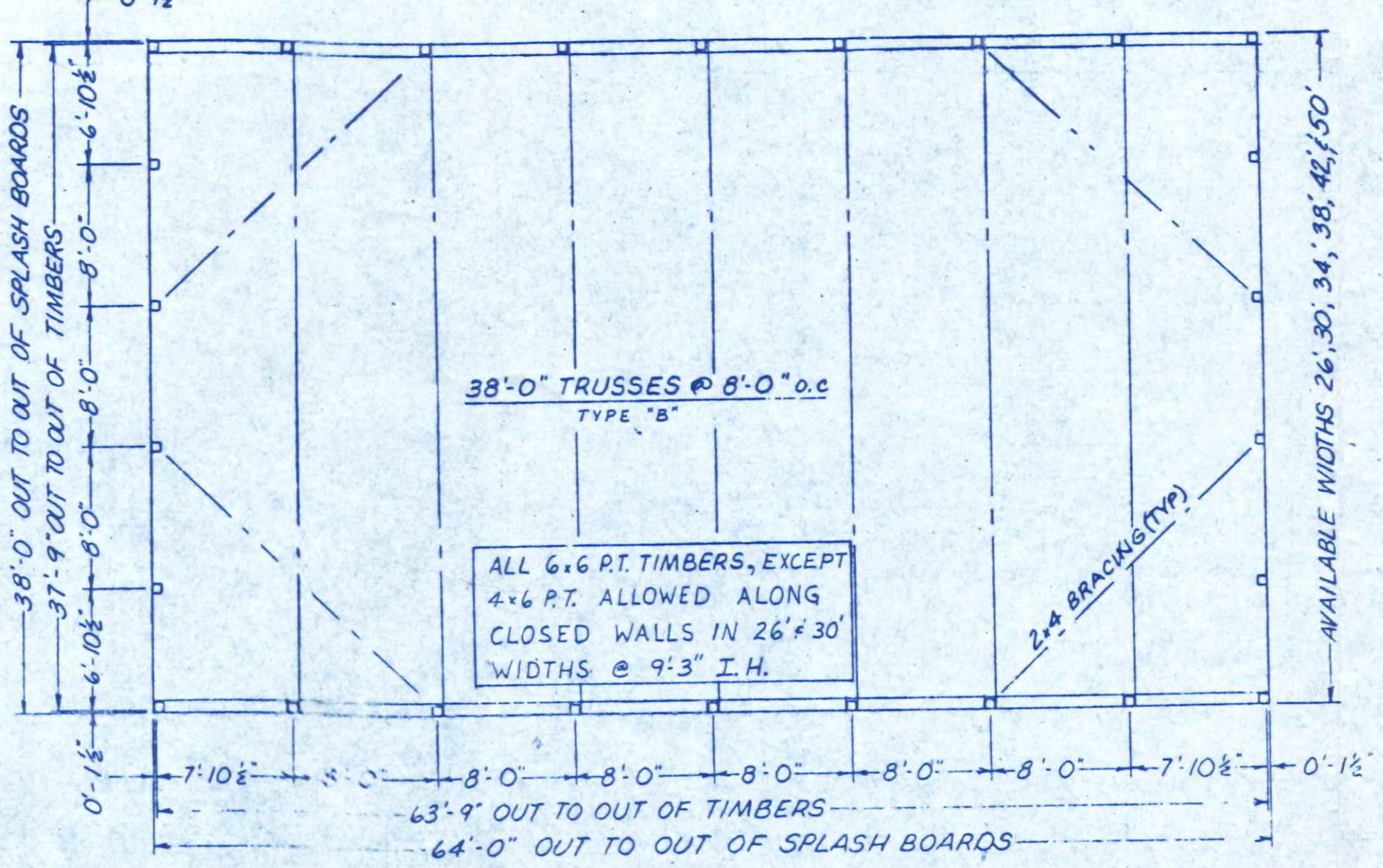

PLAN

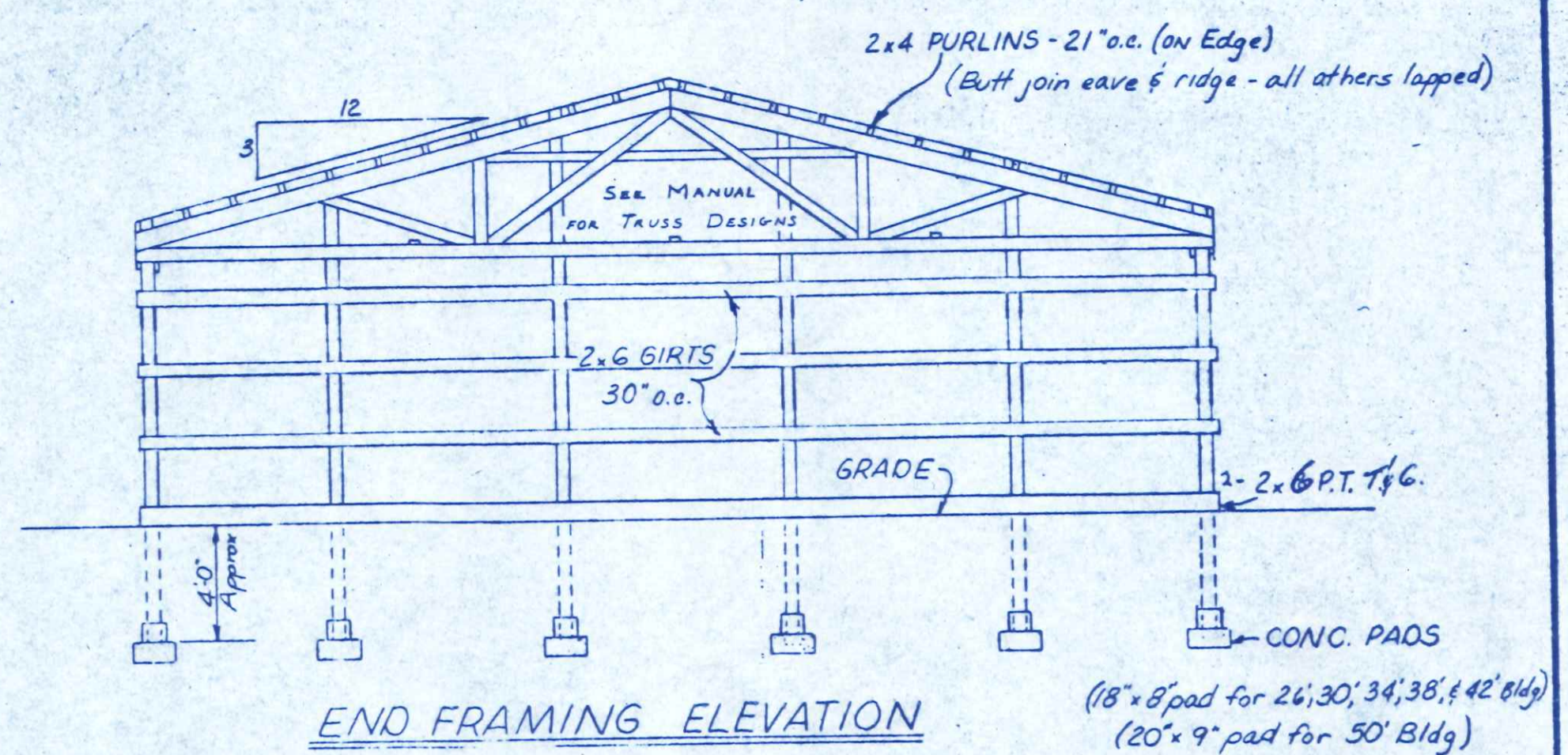

END FRAMING ELEVATION

END FRAMING TIMBER SIZING

BUILDING WIDTHS	8'-10 1/2"	8'-0"	8'-0"	8'-0"	8'-0"	8'-10 1/2"	0'-1 1/2"
26'	8'-10 1/2"	8'-0"	8'-0"	8'-0"	8'-0"	8'-10 1/2"	0'-1 1/2"
30'	8'-10 1/2"	8'-0"	8'-0"	8'-0"	8'-0"	8'-10 1/2"	0'-1 1/2"
34'	8'-10 1/2"	8'-0"	8'-0"	8'-0"	8'-0"	8'-10 1/2"	0'-1 1/2"
38'	8'-10 1/2"	8'-0"	8'-0"	8'-0"	8'-0"	8'-10 1/2"	0'-1 1/2"
42'	8'-10 1/2"	8'-0"	8'-0"	8'-0"	8'-0"	8'-10 1/2"	0'-1 1/2"
50'	8'-10 1/2"	8'-0"	8'-0"	8'-0"	8'-0"	8'-10 1/2"	0'-1 1/2"

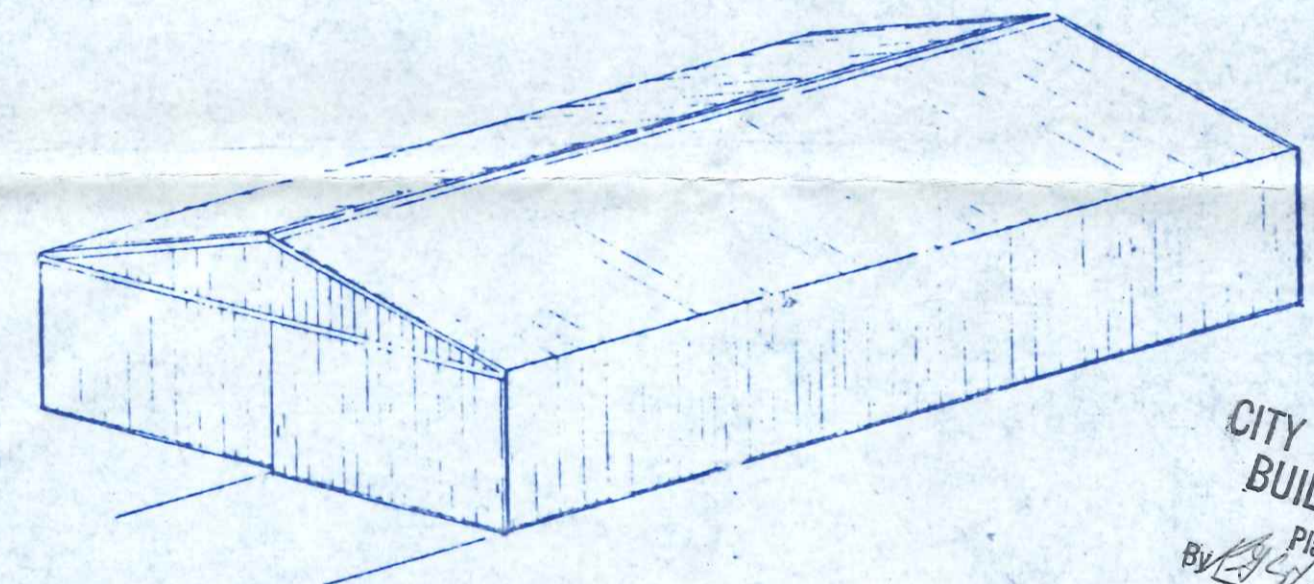
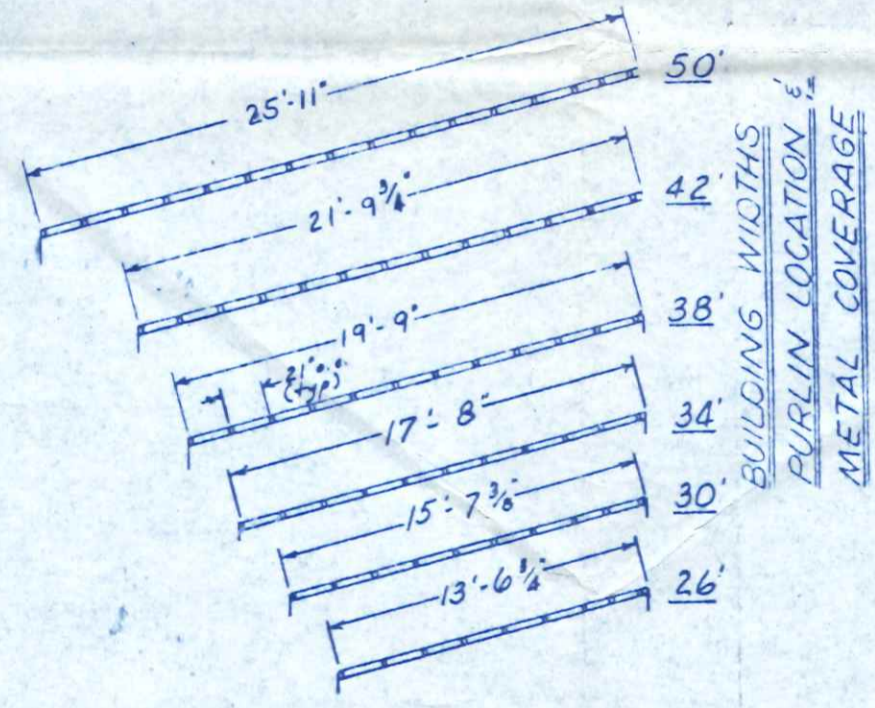

CITY OF NAPOLEON
BUILDING DEPT.
Plan Approval
By *[Signature]*
Date 9/6/84
Marford Melvin

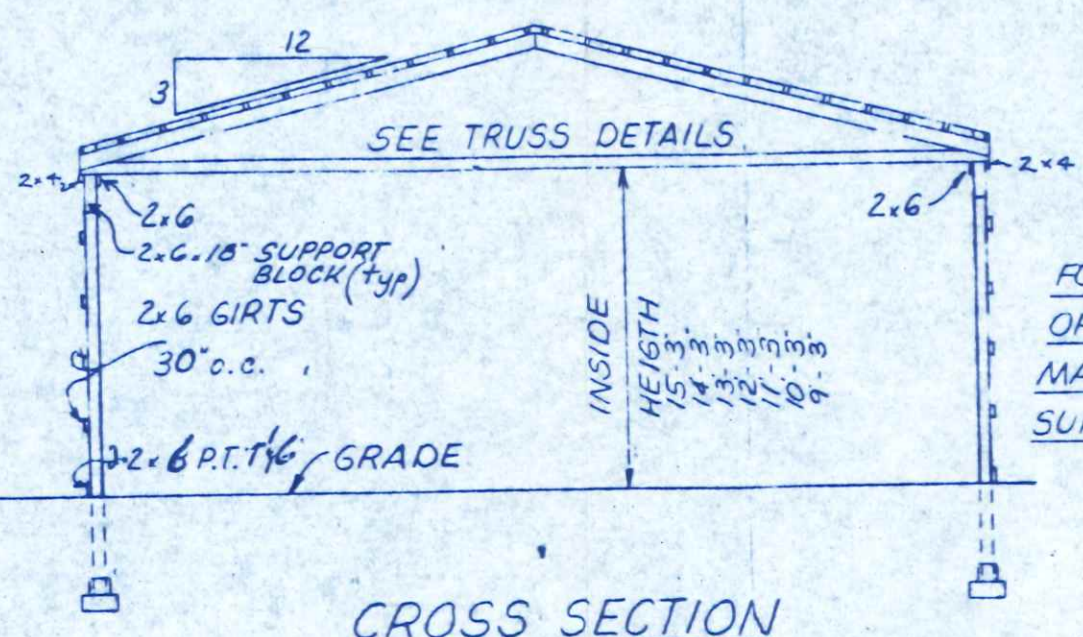
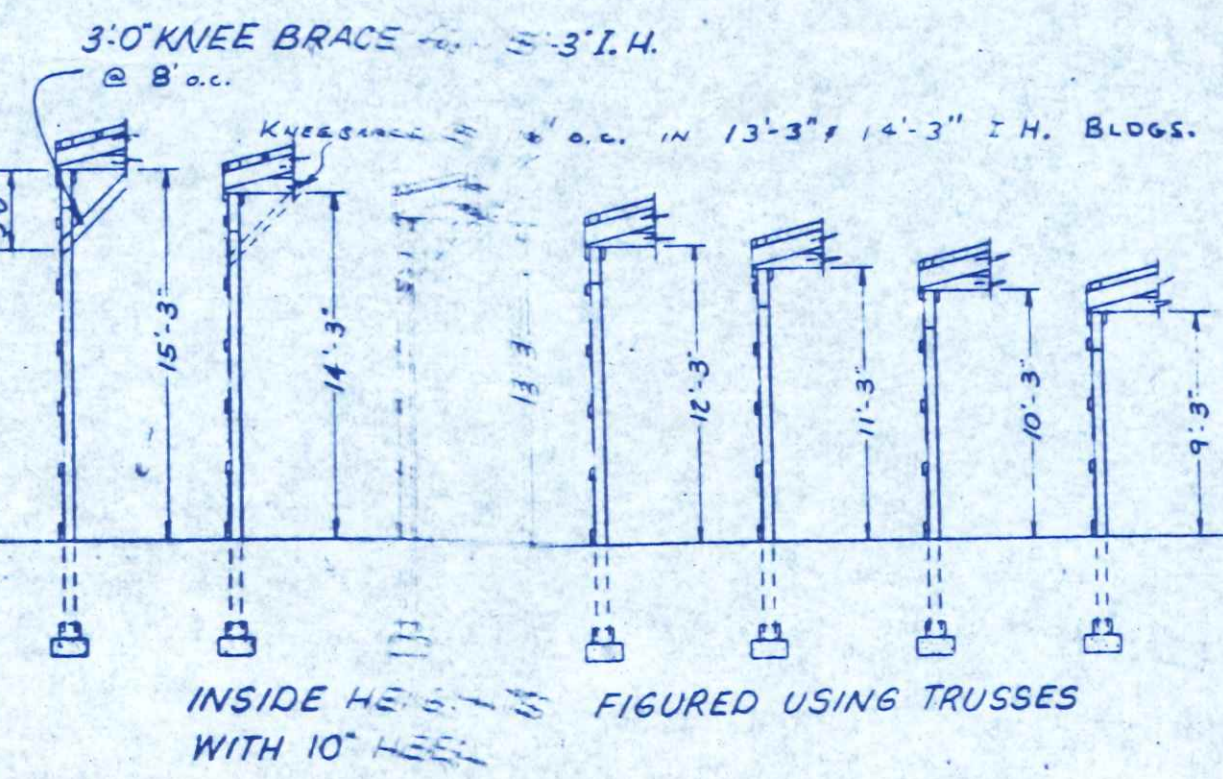

CROSS SECTION

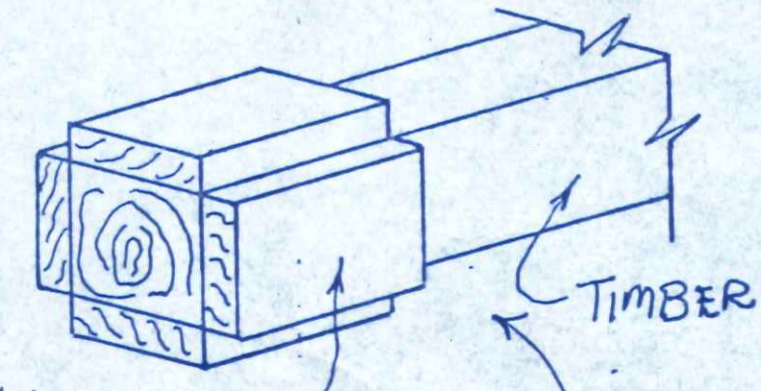

ANCHOR PAD DETAIL

BoWellCo Buildings, Inc.
P.O. Box 62 Rt. 424 E.
Napoleon, Ohio 43545



SPECIFICATION SHEET

PLAN NO. SC-300800 - BOCA

APPROVED BY <i>[Signature]</i>	REVISIONS	DRAWN BY E. RICHER	JOB NO.
DATE 10-5-84		SCALE VARIES	SHEET 1 OF 1

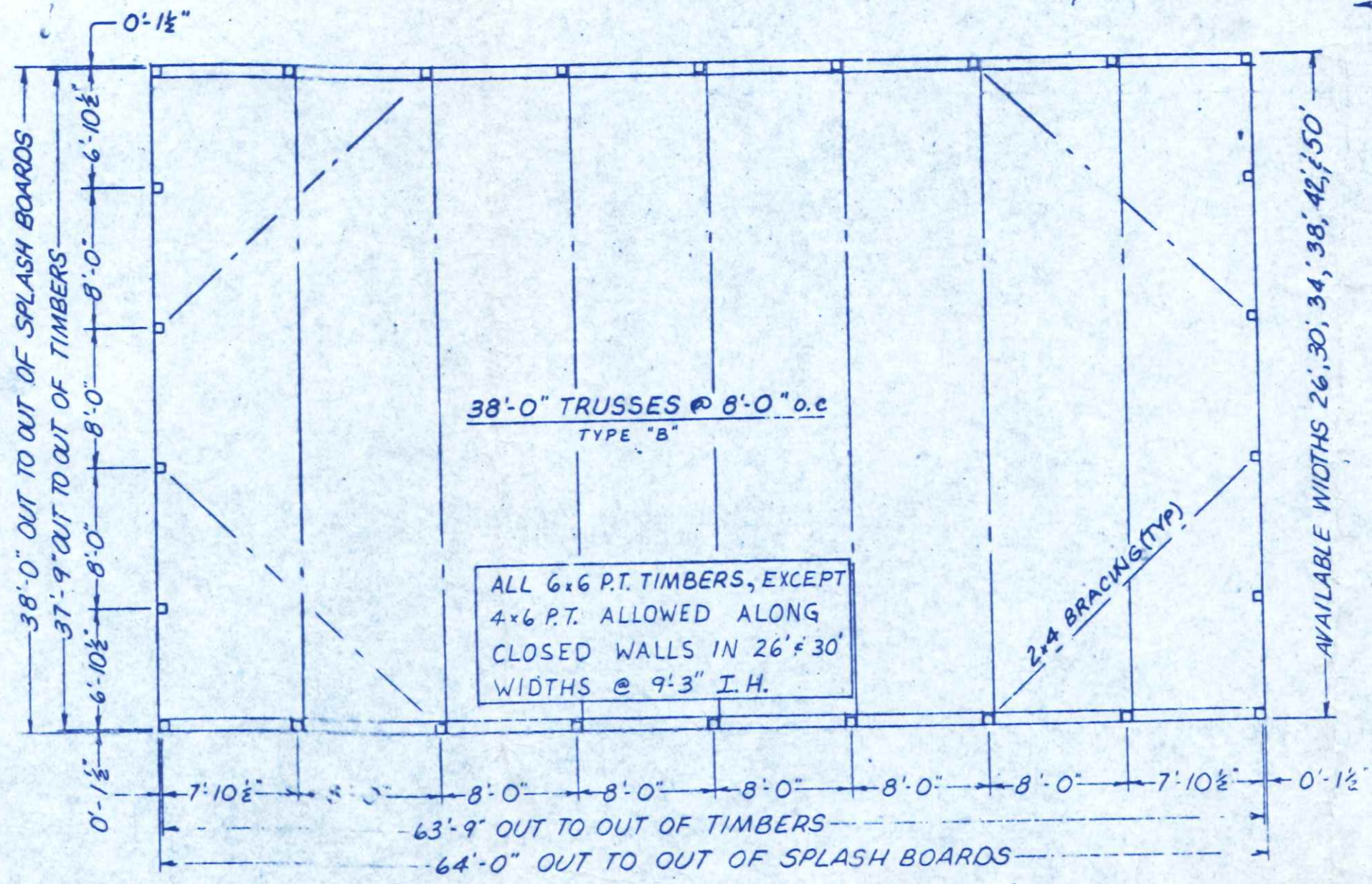
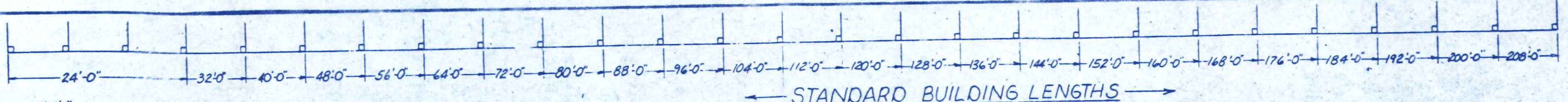

PLAN

STANDARD BUILDING LENGTHS

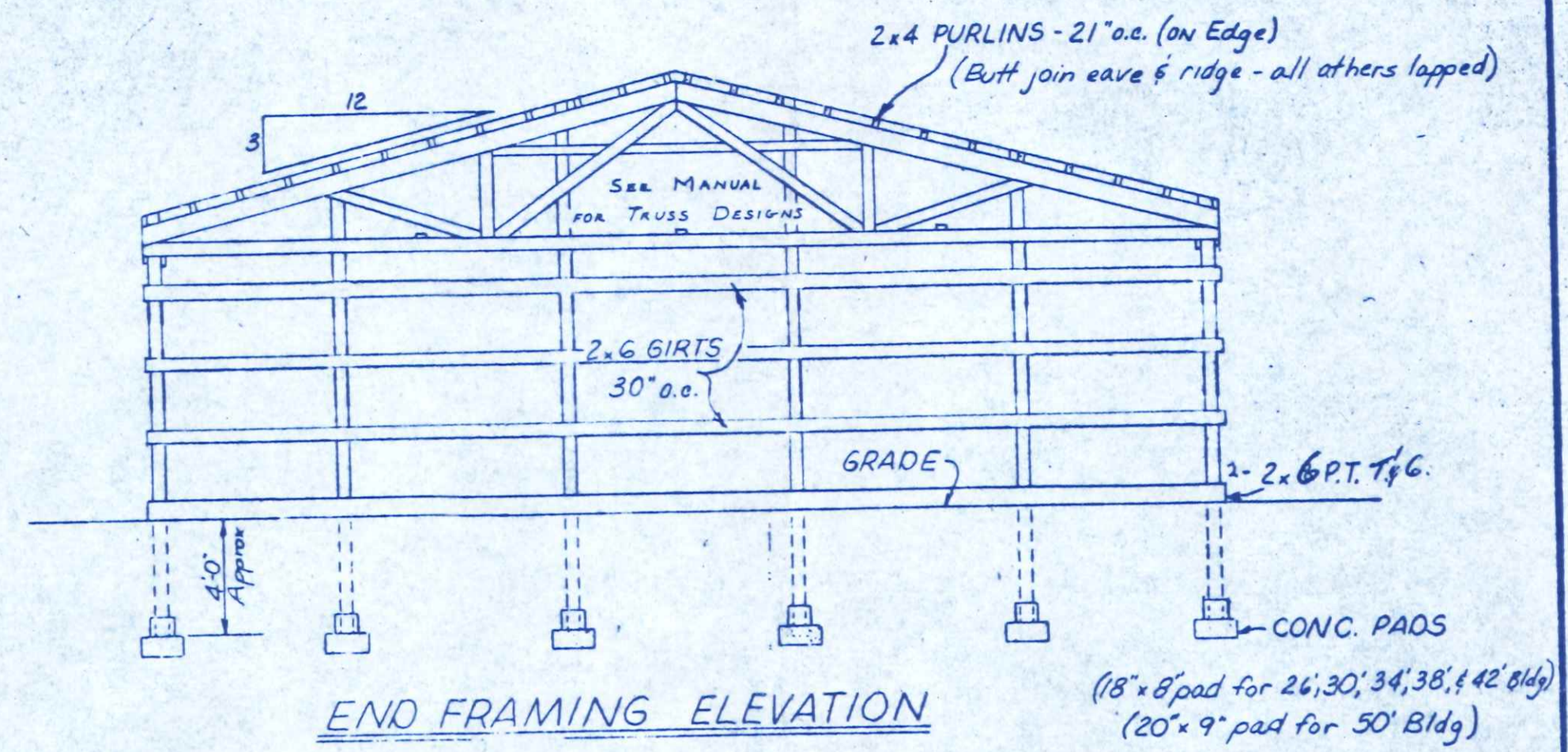

END FRAMING ELEVATION

END FRAMING TIMBER BRACING

BUILDING WIDTHS	8'-10 1/2"	8'-0"	8'-10 1/2"	0'-1 1/2"		
26'	8'-10 1/2"	8'-0"	8'-10 1/2"	0'-1 1/2"		
30'	6'-10 1/2"	8'-0"	6'-10 1/2"	0'-1 1/2"		
34'	8'-10 1/2"	8'-0"	8'-10 1/2"	0'-1 1/2"		
38'	6'-10 1/2"	8'-0"	8'-0"	6'-10 1/2"	0'-1 1/2"	
42'	8'-10 1/2"	8'-0"	8'-0"	8'-10 1/2"	0'-1 1/2"	
50'	8'-10 1/2"	8'-0"	8'-0"	8'-0"	8'-10 1/2"	0'-1 1/2"

BUILDING WIDTHS	PURLIN LOCATION	METAL COVERAGE
50'	25'-11"	
42'	21'-9 3/4"	
38'	19'-9"	
34'	17'-8"	
30'	15'-7 3/8"	
26'	13'-6 1/2"	

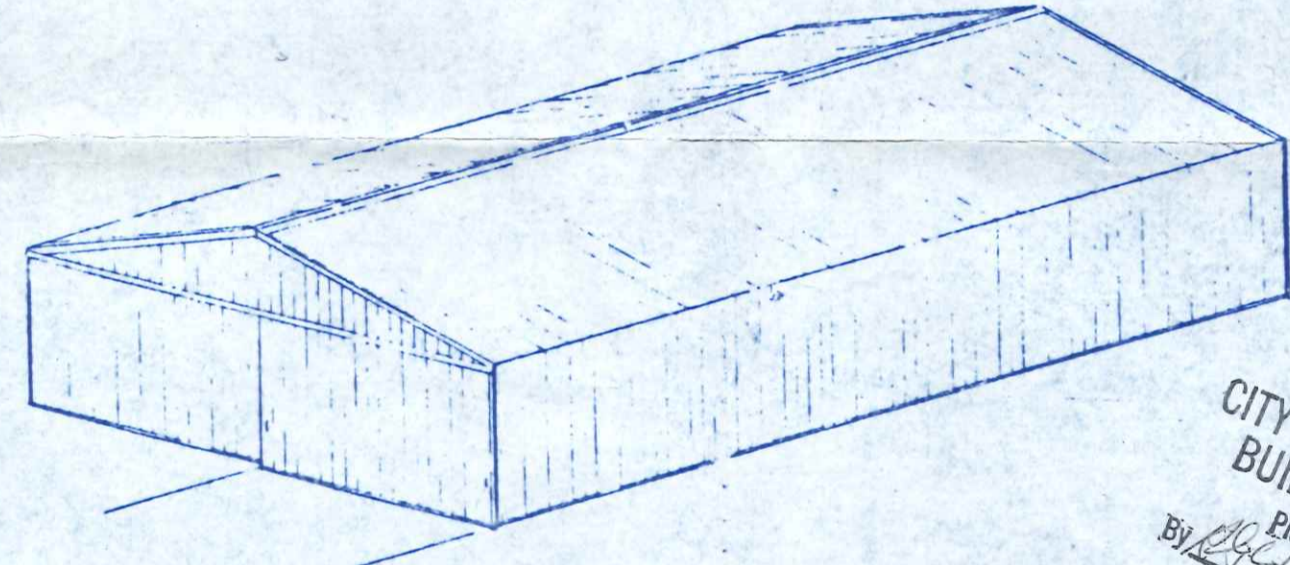

CITY OF NAPOLEON
BUILDING DEPT.
Plan Approval
By *[Signature]* Date *6/5/87*

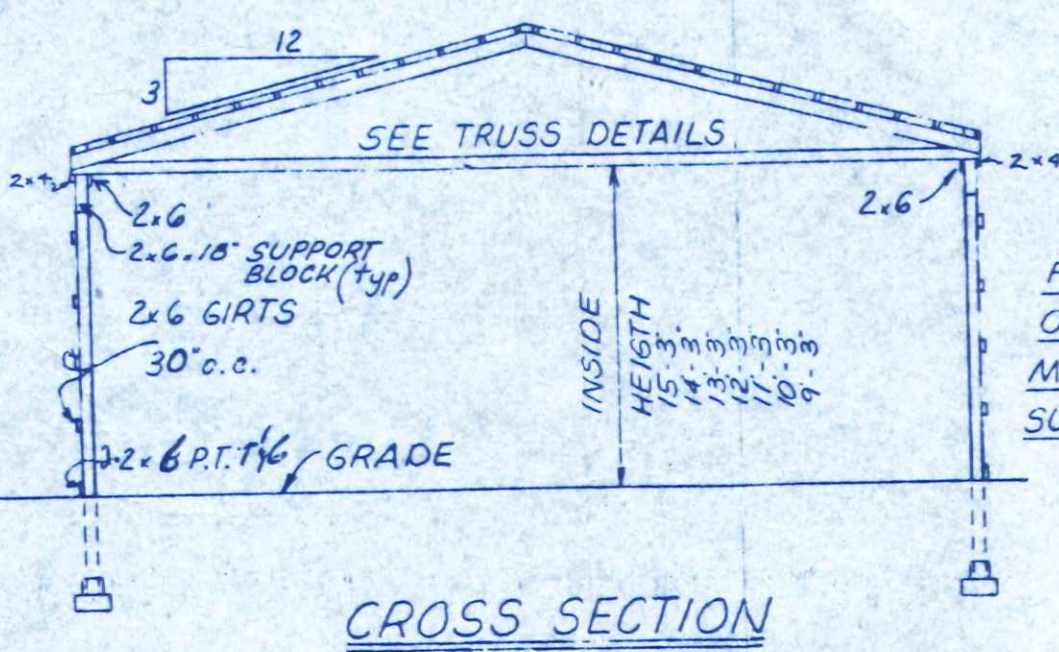
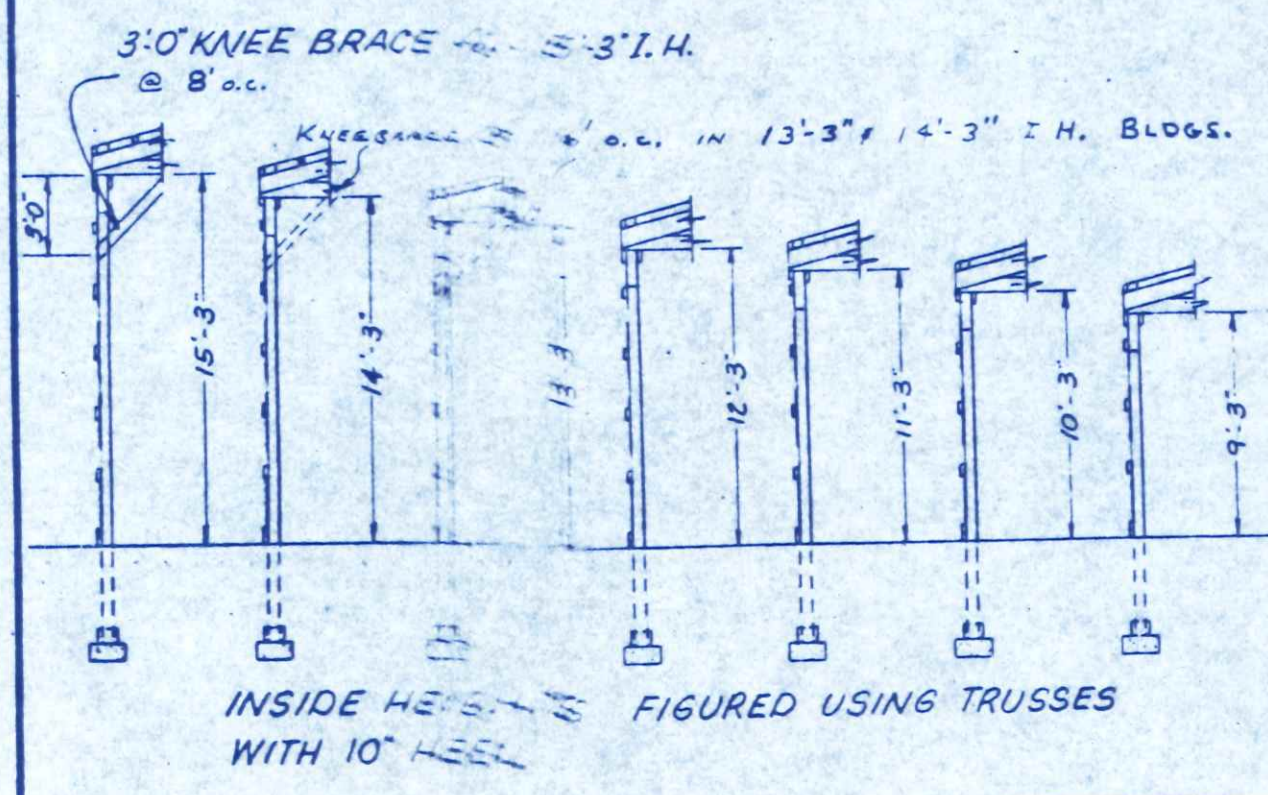

CROSS SECTION

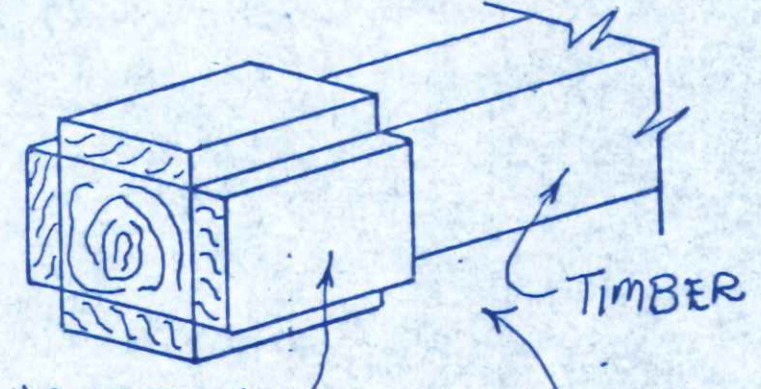

ANCHOR PAD DETAIL

BoWellCo Buildings, Inc.
P.O. Box 62 Rt. 424 E.
Napoleon, Ohio 43545

FOR ANY OPENING SEE MANUAL FOR SUPPORT SIZES



SPECIFICATION SHEET

PLAN NO. SC-300800 - BOCA

APPROVED BY: <i>[Signature]</i>	REVISIONS:	DRAWN BY: E. RICHER	JOB NO.
DATE: 7-10-87	REVISIONS:	SCALE: VARIES	SHEET 1 OF 1